

Mechanical Dimensions: Inches [mm]

Tolerances ± 0.012 [0.3] Unless Otherwise Specified

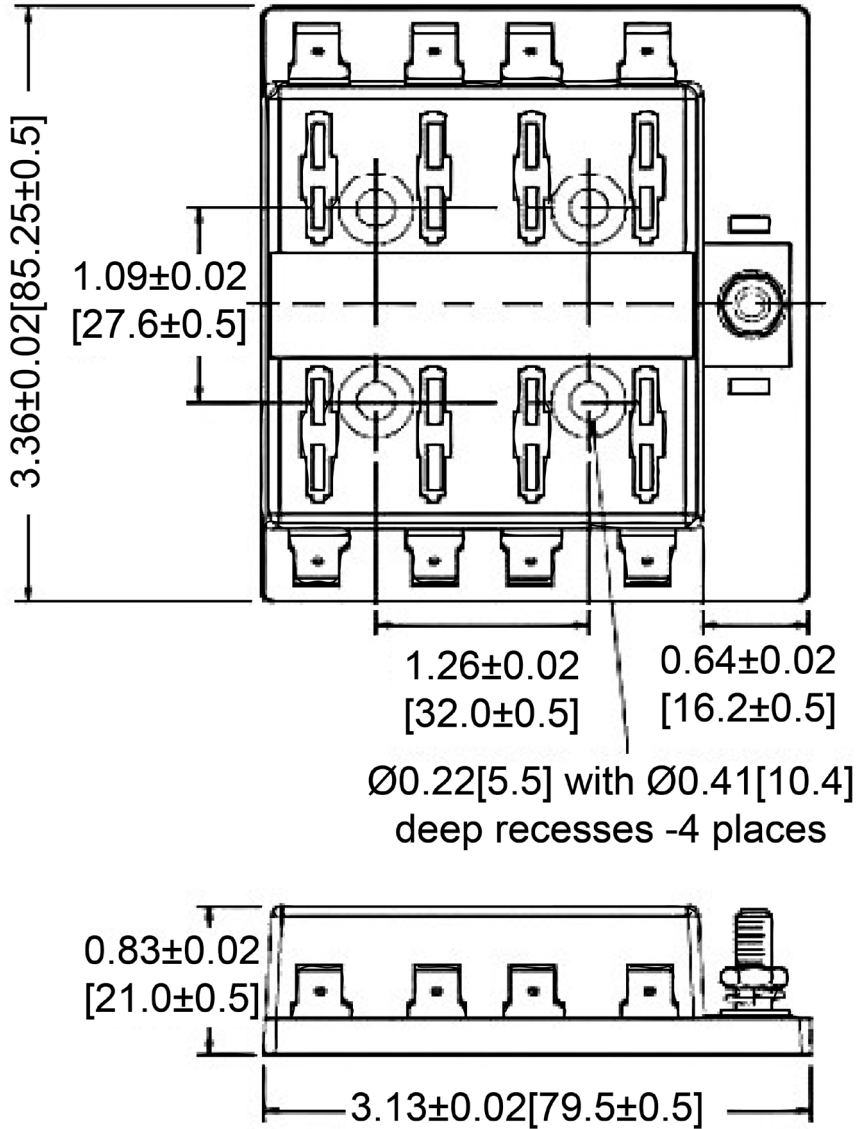

Electrical Specifications

Volate Rating	32VDC
Current Rating (Combined Circuits)	100A
Current Rating (Max Input)	25A
Line Side Connection	#10-32 Studs
Load Side Connection	0.25" Quick Connect

Material Specifications

8 Circuits	
Body Material	Polycarbonate (UL94V-2)
Terminal Material	Copper (Tin Plated)
Accepts Regular (ATO/ATC Style) Blade Fuses	
For cover please ask us about our BLC-108-C	

Isometric View

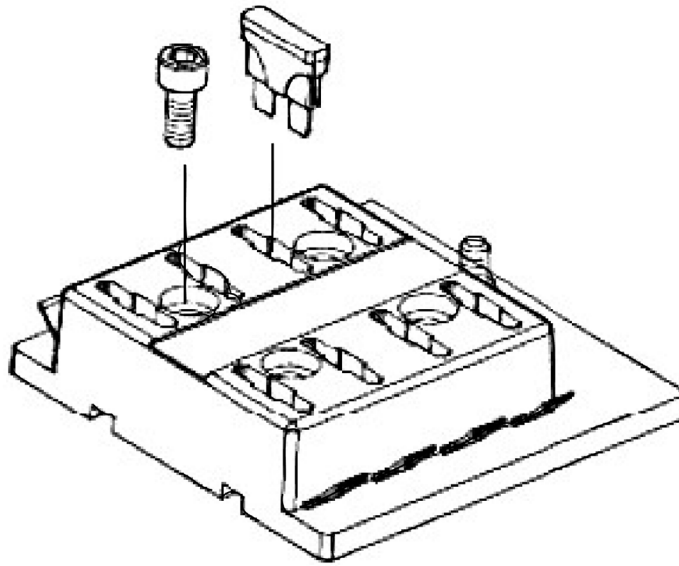

Rev	Date of issue	Revision Notes	Designed	Approved
D	07-08-2024	Updated to new style; Corrected combined circuit rating	RC	OF