

# Type CBW28 Thermal Circuit Breaker Fuseholder Type – Push to Reset



www.optifuse.com (619) 593-5050

## Specifications:

Fuseholder Type Circuit Breaker – Push to Reset

Voltage: 125/250 VAC, 50/60 Hz. and 32 VDC

Amperage: 1A, 1.25A, 1.5A, 1.75A, 2A, 2.25A, 2.5A, 3A, 3.5A, 4A, 5A, 6A, 7A,  
8A, 9A, 10A, 11A, 12A, 13A, 15A, 16A

Interrupt Capacity: 1000A @ 250 VAC, 50/60Hz. and 200A @ 32 VDC

Insulation Resistance: 100M  $\Omega$

Terminals: 0.250" [6.35mm] quick connect – Nickel plated brass.

Panel Thickness: 0.8 – 2.1mm (0.031 - 0.083 inches)

Mounting: Snap-In Front Panel Mount (See Recommended Cut Out)

## Agency Standards and Listings:



RoHS  
Compliant

## Mechanical Dimensions: Inches [mm]

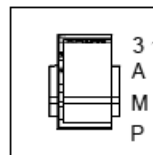
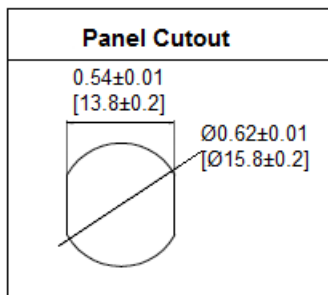

ON (Contacts Closed)

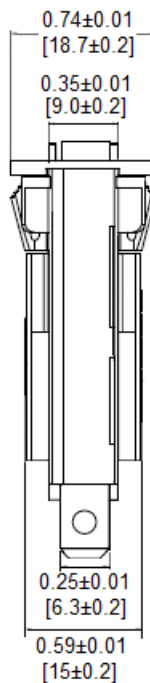
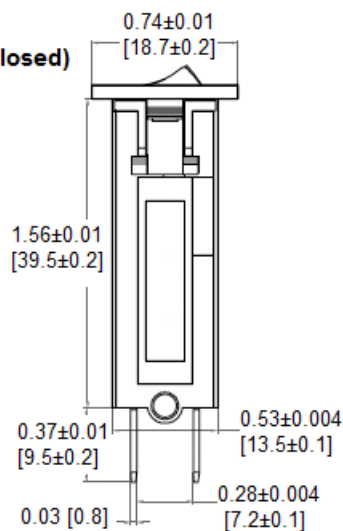

TRIP (Contact Open)

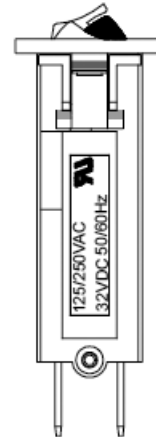

# Type CBW28 Thermal Circuit Breaker Fuseholder Type – Push to Reset



www.optifuse.com (619) 593-5050

### Calibration:

Electrical Data @ 25°C

Continuously Carried at 100% of Rated Current

1A-2.5A: May Trip between 101% to 149%

3.0A-16A: May Trip between 101% to 134%

1A-2.5A: Must Trip at 150% of Rated Current within 1 Hour

3.0A-16A: Must Trip at 135% of Rated Current within 1 Hour

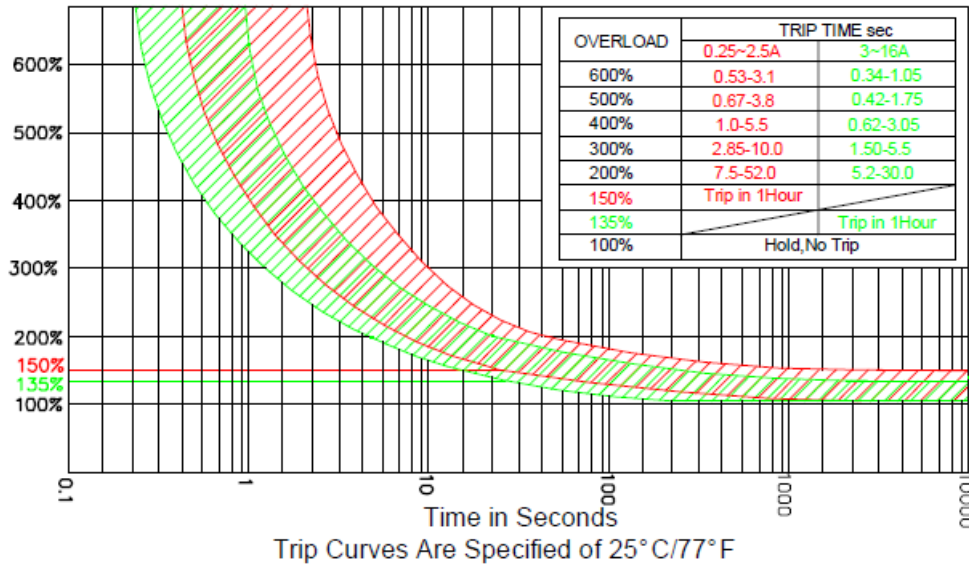

### Ambient Compensation Chart

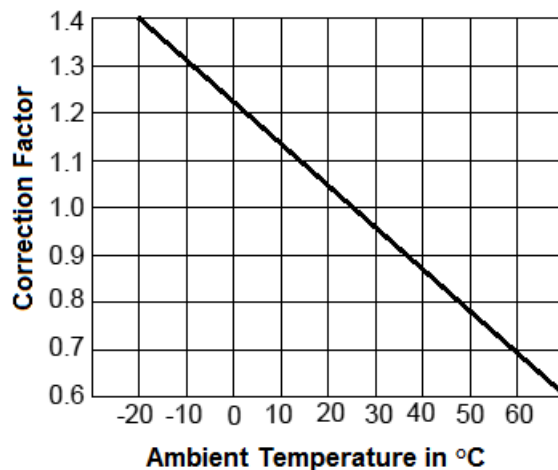

Ambient Temperature Correction Factor:

The time/current characteristic curve depends on the ambient temperature prevailing. In order to eliminate nuisance tripping. Please multiply the current breaker current ratings by the derating factor shown above.

### Warning:



- Operation beyond the specified maximum ratings or improper use may result in damage and possible electrical arcing and/or flame.
- Device are intended for occasional overcurrent protection. Application for repeated overcurrent condition and/or prolonged trip are not anticipated.
- Avoid contact of device with chemical solvent. Prolonged contact will damage the device performance.

Note: All specifications subject to change without notice.

Rev F 02/2013 - Page: 2/2  
Code K01-01H