

Type PMG-DS-01-Q2S
Panel Mount Fuse Holder
13/32" x 1½" (10.3 x 38.1mm)
Driver / Screw



www.optifuse.com (619) 593-5050

Electrical Rating: 30A, 600V AC
Fuse Style: 13/32" x 1½" (10.3 x 38.1mm)
Material:
Frame and Cap: Phenolic (UL flame: 94V-1)
Terminals: Nickel-plated brass
Cap: Slotted Driver type, Screw type
Mounting: by metal nut with white washer
Terminal: Solder/Quick-connect 6.4mm / 0.250"
Panel Thickness: 0.5 ~ 15.5mm
Agency Standards and Listings:



Product Dimensions: Inches [mm]

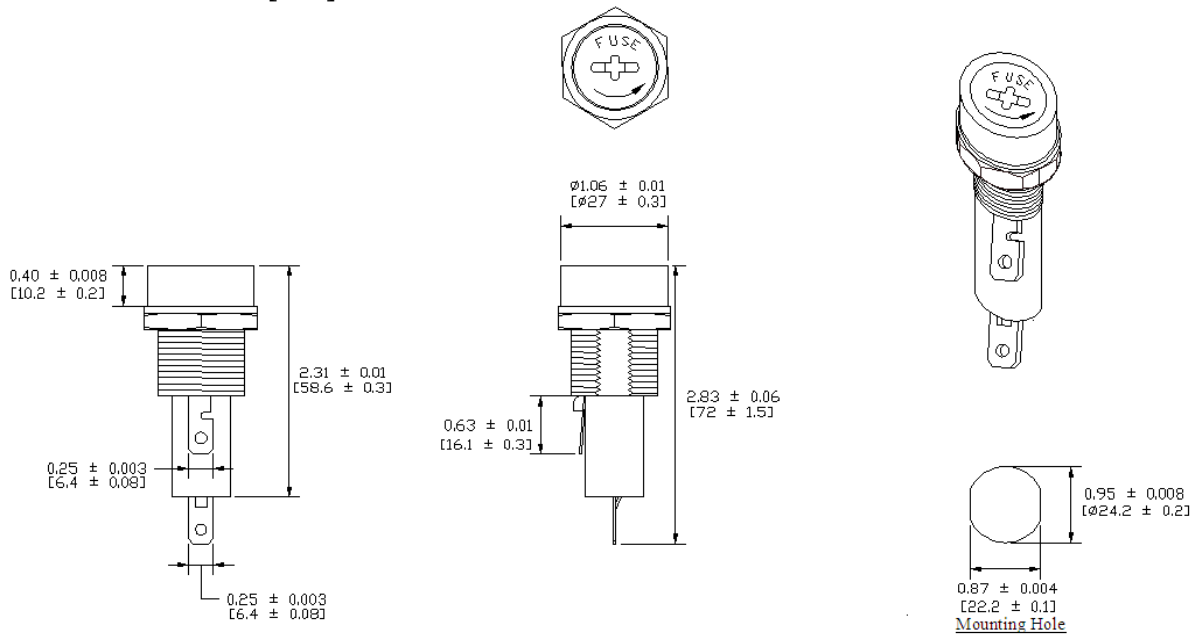

Warning:



-Operation beyond the specified maximum ratings or improper use may result in damage and possible electrical arcing and/or flame.
 -Fuse Holders are not intended for circuit disconnect. All power should be disconnected before removing fuse.
 -Avoid contact of Fuse Holder with chemical solvent. Prolonged contact may damage the device performance.